

Article number: 201092659
 Description: E+G Stainless lock pin
 GN 114.3-10-25

Measures

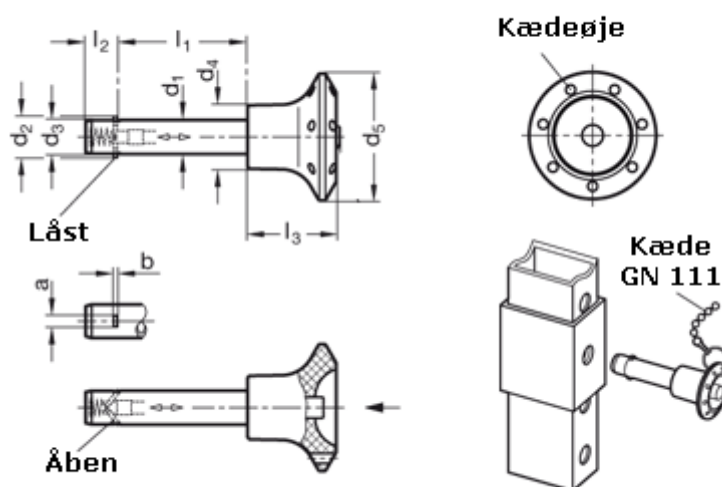

a	= 3,3	l1 = 25
b	= 1	l2 = 9,8
Clamping force (kN)	= 40	l3 = 26
d1	= 10	
d2	= 12,8	
d3	= 9,9	
d4	= 18	
d5	= 34	